

"Your Connection"

PA08 Series 1.25mm(.049") FFC/FPC Connectors

- ⊙ Standard with Tube packing
- ⊙ Tin plated contacts with kinked tail
- ⊙ Insulation: Glass filled polyester UL 94V-0, Color Black
- ⊙ Accommodates 0.3mm FFC/FPC thickness
- ⊙ Engineering No's: CF12 Series

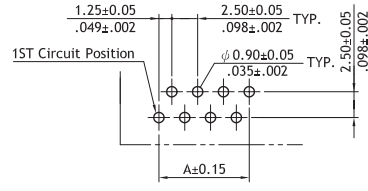
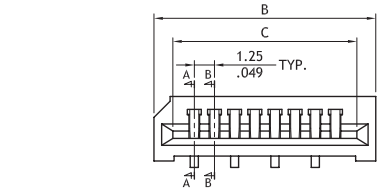

A = 1.25 x No. of Spaces
 B = A + 5.0
 C = A + 2.66
 * Available in 3 through 36 circuits

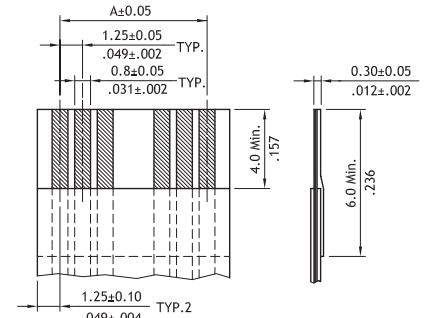
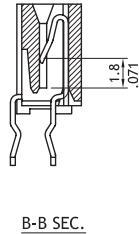
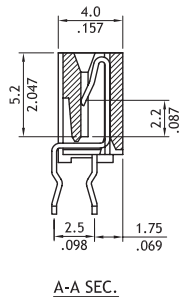
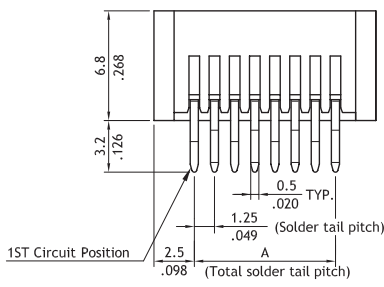

* ACCOMMODATED FFC

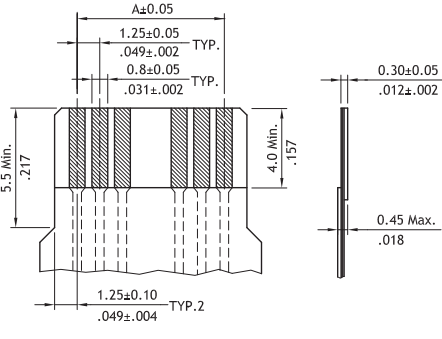
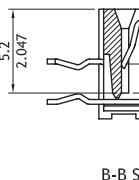
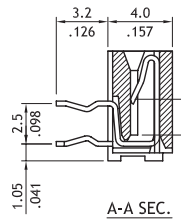
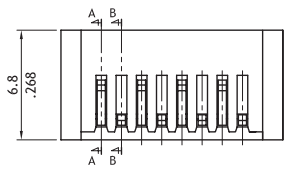
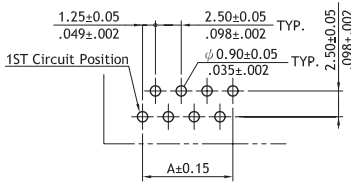
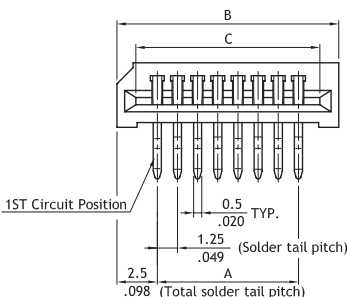

* ACCOMMODATED FPC

Ordering Code

1 PA08 2 33 3 1 4 V0 5 T 6 0

- 1** Series No.
- 2** Circuits : 03 to 36
- 3** Plating code:
1= Tin over Nickel
- 4** Contact style:
V0= Straight
H0= Right angle
- 5** Packing: T= Tube Packing
- 6** Other options:
0= Standard
* Special options Consult factory